



Tenda a caduta, dal design ricercato, con doppio rullo avvolgitore, per telo estivo e invernale. Telo invernale semitrasparente inserito nella doppia guida dotata di doppio spazzolino per riparo dal vento.

Supporti e snodi in alluminio pressofuso, garantiscono un'ottima resistenza e qualità estetica.

Profilo terminale rinforzato, con chiavistelli, permette una perfetta tensione del telo.

Guarnizione in PVC morbido, adatta agli eventuali dislivelli del pavimento. Braccetti a sporgere da 75 cm. con frangivento intermedio e fermi automatici. Optional: 2 motori radio con finecorsa elettronico e riconoscimento degli ostacoli con telecomando o 2 motori elettronici con programmazione a pulsantiera e riconoscimento degli ostacoli.

Vertical blind by refined design, with double roll for summer cloth and winter cloth. A semi-transparent cloth works vertically in double rail equipped with double brush for wind protection. Components in die-casted aluminium, which guarantee an excellent resistance and aesthetic quality.

Reinforced front bar profile, with bolts, allowing a perfect tension on winter cloth. End gasket in soft PVC for covering unlevelled floors.

Sliding arms of 75 cm with middle wind-break and automatic block.

The structure can be equipped with the following options: Exterior cassette with screws and brush, Internal cassette with screws, brush and plates, Middle wind-break for winter cloth.

Optional: n.2 RTS motors with electronic end regulation and obstacle identification with remote control or n.2 electronic motors regulated by button programming and obstacle identification.



Standard

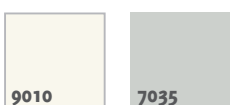

Optional



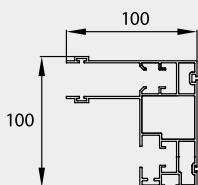
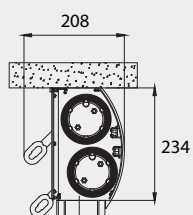

Profilo guida
Rail profile

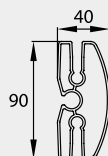

Profilo terminale
invernale
*Front bar profile
winter cloth*

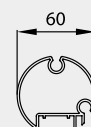

Profilo terminale
braccetti
*Front bar profile
for arms*



Profilo frangivento
braccetti
*Wind-break arm
profile*

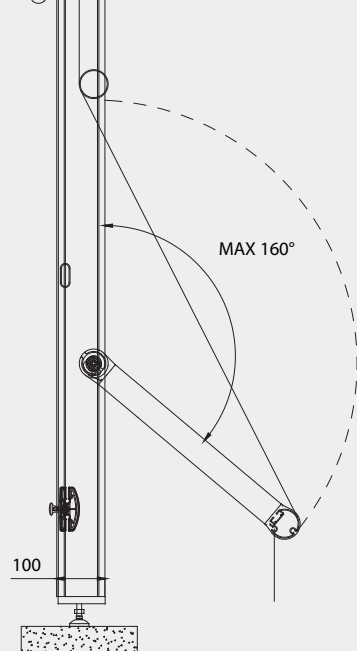

OPTIONAL

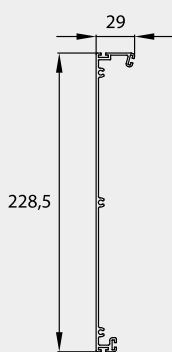

Profilo cassetto interno
Internal cassette profile

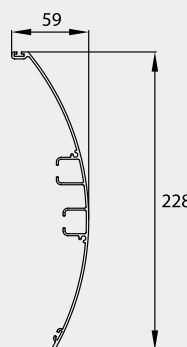

Profilo cassetto
esterno
External cassette profile

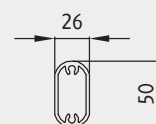

Profilo frangitratta
intermedio
Middle wind-break