

F 11252x66/52x80 catena COMBINATA - *COMBINED chain*
rullo - tube Ø 49 mm**SERIE F - F SERIES**

UNI EN13120:2014

dimensioni in mm
dimensions shown in mm

52x66

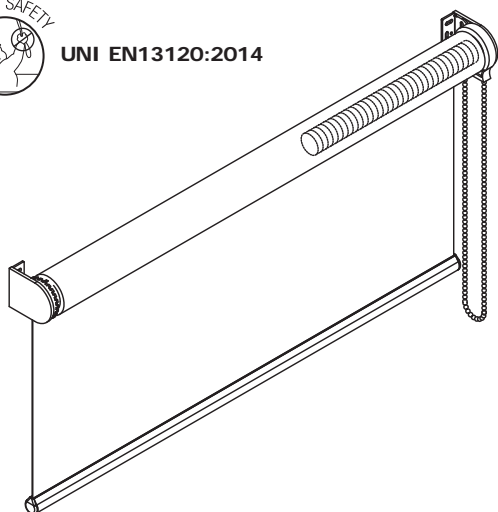
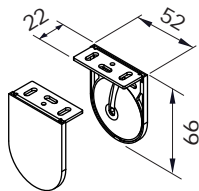
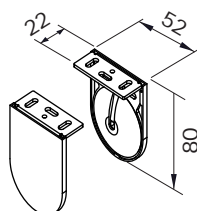

52x80

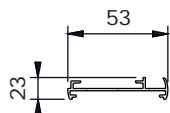
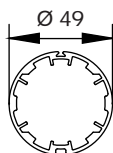
profilo di premontaggio
aluminum frame

rullo - tube

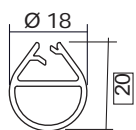

F21 Serie 2012

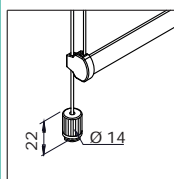
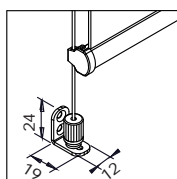
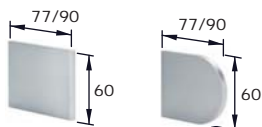
varianti - optionalfondale FR23 e cavo perlon
Φ1,2mm con tenditore per
fissaggio piano orizzontale,
con staffe in acciaio per piano
verticaleFR23 hem bar and Φ1.2mm
perlon cable with cable
tensioning block for window
sill/floor mounting or brackets
for wall mountingcopri staffe magnetici in
alluminio satinato
satin finish aluminium
magnetic bracket covers.**CARATTERISTICHE:****Tipo di applicazione:** verticale. per grandi dimensioni
Ambiente di applicazione: interno. Larghezza minima
80 cm**Staffe di fissaggio:** 52x66 mm in ferro verniciato con
copri staffe in PVC (bianco, nero, grigio); staffa 52x80
mm su richiesta. A supplemento copri staffe magnetici in
alluminio satinato.**Rullo di avvolgimento:** Ø 49 mm in alluminio estruso
con ogiva per facilitare la manutenzione del telo**Fondale:** F21 Serie 2012 in alluminio estruso con tappi
in PVC. Fondale FR23 con la variante guida cavo perlon.**Manovra:** a catena combinata con comando frizionato
EASY LOCK in PVC completo di calotta lato opposto
con perno rientrante per facilitare lo smontaggio del
rullo dalle staffe e molla di richiamo per agevolare il
sollevamento del telo. Catena passo 6 in nylon con grani
in PVC Ø 4,5 mm dotata di sgancio di sicurezza "child
safety device" secondo la norma UNI EN13120:2014**Fissaggio:** a parete o a soffitto. A supplemento profilo di
premontaggio in alluminio estruso verniciato (bianco Ral
9010 - nero Ral 9005 opaco - argento anodizzato)**CHARACTERISTICS:****Application:** vertical**Installation:** indoors. Minimum width 80 cm**Brackets:** 52x66 mm steel powder coated brackets with PVC
covers (white, grey, black), 52x80 mm on request.

Supplement for satin finish aluminium magnetic bracket covers.

Roller tube: Ø 49 mm extruded aluminum tube with
slot to facilitate fabric removal**Hem bar:** F21 Serie 2012 extruded aluminum hem bar
with PVC caps. FR23 hem bar supplied with guided blind
with cable.**Operation:** combined chain operation with EASY LOCK
control unit and opposite side end plug with retractable pin to easily
remove the tube from the brackets and compensating spring to
assist roll-up. Ø 4,5 mm PVC/nylon bead chain,
6 mm pitch, with incorporated child safety device -
UNI EN13120:2014**Mounting:** wall or ceiling. Supplement for powder coated
premounting frame (white Ral 9010 - matt black Ral 9005 -
silver anodised)**note - notes**fondale in alluminio estruso FR23 in abbinamento alla
variante con cavi - *guided blind with cables supplied with
FR23 extruded aluminium hem bar*il sistema è comprensivo di molla di richiamo che agevola
il sollevamento del telo - *compensating spring to assist roll-
up included***colori standard - standard colours**bianco Ral 9010 - *white Ral 9010*avorio Ral 1013 - *ivory Ral 1013*marrone Ral 8017 - *brown Ral 8017*nero Ral 9005 opaco - *matt black Ral 9005*argento anodizzato - *silver anodised***tessuti abbinabili - suitable fabrics**da utilizzare con tessuti superiori a 350 g/m²
per l'utilizzo dei tessuti consultare la sezione dei teli
confezionati e/o Tabella "A"*Suitable for heavy fabrics (over 350 g/m²)
for fabric choice consult the fabric section and Tab. "A"***supplementi - supplement**